

Your Malaysia CheatSheet ♥

Malaysia 101

- **Overview of Kuala Lumpur (KL):** Established in 1857, KL is a dynamic city known for its stunning architecture, thriving business scene, and rich cultural heritage.
- **Cityscape:** Blend of modern skyscrapers and traditional buildings. Iconic Petronas Twin Towers.
- **Economic and Cultural Hub:** Major financial institutions, tech industry, and diverse cultural mix.
- **Climate:** Tropical with high humidity; 25°C to 32°C all year-round.
- **Transportation:** Efficient public transport including LRT, MRT, and monorail. Major highways.
- **Ethnic Diversity:** Malays, Chinese, Indians, and indigenous peoples.
- **Festivals:** Hari Raya Aidilfitri, Chinese New Year, Deepavali, Gawai Dayak.
- **Languages:** Bahasa Malaysia (official), English widely spoken.

Getting to Kuala Lumpur

- **Kuala Lumpur International Airport (KLIA):** Main gateway, 45 km south of KL. Two terminals: KLIA Main and KLIA2.
- **Airlines:** Malaysia Airlines, AirAsia, Singapore Airlines, Emirates.
- **Travel Time to KLIA:** 45-60 mins by car/taxi, 28 mins by KLIA Ekspres, 1-1.5 hours by bus.

MYBW Conference Details

- **Venue:** World Trade Centre Kuala Lumpur (WTC KL), Jalan Tun Ismail.
- **Facilities:** On-site dining, ample parking, accessible by LRT, buses, taxis, and ride-hailing services.

- **Event Highlights:** Keynote speakers, panel discussions, workshops, networking sessions.
- **Social Media:** [Website](#), [Twitter](#), [Telegram](#), [LinkedIn](#).

Accommodation Options

- **Luxury Hotels:** AC Hotel Kuala Lumpur (1.5 km), Hotel Stripes Kuala Lumpur (2.0 km), Sheraton Imperial Kuala Lumpur Hotel (2.5 km), JW Marriott Hotel Kuala Lumpur (3.0 km), The Ritz-Carlton, Kuala Lumpur (3.5 km), The Majestic Hotel Kuala Lumpur, Autograph Collection (4.5 km), Grand Hyatt Kuala Lumpur (5.0 km), Hilton Kuala Lumpur (6.5 km), Seri Pacific Hotel (0.1 km).
- **Comfort Hotels:** Leo Palace Hotel (0.4 km), Sunway Putra Hotel (0.2 km).
- **Standard Hotels:** Intercontinental (5.0 km), Shangri-La Kuala Lumpur (3.0 km), The Ruma (4.0 km)

***Please note that once all rooms are fully reserved, we will no longer be able to accept any further booking requests. We encourage you to make your reservations early to secure your accommodation. Thank you for your understanding.*

HOTEL
STRIPES
KUALA LUMPUR

AUTOGRAPH COLLECTION
HOTELS



THE RITZ-CARLTON

KUALA LUMPUR



AUTOGRAPH COLLECTION
HOTELS

Transportation in Kuala Lumpur

- **Public Transport:** LRT (PWTC Station), MRT (Muzium Negara), Go KL City Bus (free service).
- **Ride-Hailing:** Grab, MyCar, AirAsia MOVE.

AirAsia Move Limited Time Offer

- **Availability:** Download on [iOS](#) or [Android](#).

MYBW2024 (RM3 Off x 2 rides)

1. Voucher is valid for both new and existing users.
2. Valid for two (2) redemptions per user.
3. airasia ride shall be available to users on a best effort basis.
4. Toll fare is not included in the fare price displayed on the mobile application after setting the destination.
5. Voucher is not valid for ongoing promotions, discounts, vouchers and/or privileges.
6. Offer purchased is not refundable/exchangeable with other promotions/offers.
7. No cancellation is allowed after the voucher has been redeemed.
8. Any surplus or remaining balance from the total amount must be paid directly by the customer or user.
9. Voucher is only applicable within the Federal Territory of Kuala Lumpur.
10. Promotion is valid from 27 July 2024 - 4 August 2024.
11. Terms and conditions of AirAsia Ride Sdn. Bhd. applies.

MYBWRIDE (RM5 Off x 2 rides Airport)

1. Voucher is valid for both new and existing users.
2. Valid for one (2) redemption per user.
3. airasia ride shall be available to users on a best effort basis.

4. Toll fare is not included in the fare price displayed on the mobile application after setting the destination.
5. Voucher is not valid for ongoing promotions, discounts, vouchers and/or privileges.
6. Offer purchased is not refundable/exchangeable with other promotions/offers.
7. No cancellation is allowed after the voucher has been redeemed.
8. Any surplus or remaining balance from the total amount must be paid directly by the customer or user.
9. Voucher is only applicable to/from KLIA1, KLIA2 and Sultan Abdul Aziz Shah Airport.



- **Car Rentals:** Hertz, Avis. Driving tips: Drive on the left, use Google Maps/Waze.

Staying Safe in Kuala Lumpur

- **General Tips:** Avoid displaying valuables, use reputable transportation services.
- **Health Services:** Emergency numbers (999), hospitals (Hospital Kuala Lumpur, Prince Court Medical Centre).
- **Emergency Contacts:** Police, Fire, Ambulance: 999.

Exploring Kuala Lumpur

- **Top Attractions:** Petronas Twin Towers, KL Tower, Batu Caves, Merdeka Square, National Museum, Thean Hou Temple, Perdana Botanical Garden, KL Forest Eco Park.
- **Cultural Sites:** Central Market, Petaling Street (Chinatown).

Food and Dining

- **Must-Try Dishes:** Nasi Lemak, Satay, Laksa, Roti Canai, Char Kway Teow, Hainanese Chicken Rice, Cendol.
- **Restaurants Near WTC KL:** Restoran Kin Kin, Havelly Restaurant, Mohd Yaseen Nasi Kandar, Restoran Mee Rebus Abdullah, Café Capitol, Shin Ong Lai Restaurant, Nando's, Onde Onde, Restoran RSMY, Boat Noodle.

Ghetto Spots in Kuala Lumpur

- **Nightlife:** Gēmu Club, Havana Bar & Grill, Jalan Changkat Bukit Bintang, The Iron Fairies KL, Marini's on 57, TREC Kuala Lumpur, Heli Lounge Bar, WET Deck at W Kuala Lumpur, No Black Tie, Pisco Bar.

Shopping in Kuala Lumpur

- **Malls:** Pavilion KL, Lot 10, Fahrenheit 88, The Exchange TRX, Suria KLCC, Mid Valley Megamall.
- **Markets:** Central Market, Petaling Street, Kasturi Walk.

Essential Apps

- **Transportation:** Grab, MyCar, KLIA Ekspres.
- **Food Delivery:** AirAsia, GrabFood, Foodpanda.
- **Navigation:** Google Maps, Waze.
- **Language:** Google Translate, Papago.
- **Local Services:** MySejahtera, Go KL City Bus.

Departure from Kuala Lumpur

- **Travel Documents:** Passport, visa, flight tickets.
- **Airport Procedures:** Online check-in, arrive 3 hours before international flights.
- **Staying Connected:** Contact information, follow-up with new connections.

Table of Content

Welcome to Kuala Lumpur: Your Guidebook for Overseas Visitors.....	2
Malaysia 101.....	3
Getting to Kuala Lumpur.....	6
Conference Details.....	8
Accommodation Options in Kuala Lumpur.....	9
Transportation in Kuala Lumpur.....	14
Staying Safe in Kuala Lumpur.....	17
Exploring Kuala Lumpur.....	19
Food and Dining.....	22
Ghetto Spots in Kuala Lumpur.....	26
Shopping in Kuala Lumpur.....	29
Cultural Etiquette and Customs.....	32
Useful Information.....	34
Essential Apps.....	37
Departure from Kuala Lumpur.....	40

Welcome to Kuala Lumpur: Your Guidebook for Overseas Visitors

Welcome to the vibrant city of Kuala Lumpur! To ensure you have a smooth and enjoyable stay, we've put together this handy guide with essential tips and information. Whether you're here for the conference at WTC KL (formerly PWTC) or simply to explore, this guidebook covers everything you need to know.

Inside, you'll find:

- **Malaysia 101:** An overview of the beautiful land of Malaysia.
- **Getting to Kuala Lumpur:** Key travel information for a seamless arrival.
- **MYBW Conference Details:** All you need to know about the conference, including schedules and venue facilities.
- **Accommodation Options:** Recommendations for luxury and budget-friendly hotels near WTC KL.
- **Transportation:** Tips on navigating the city using public transport, car rentals, and ride-hailing services.
- **Staying Safe:** Important safety tips, health services, and emergency contacts.
- **Exploring Kuala Lumpur:** Must-see landmarks and cultural sites to enrich your visit.
- **Food and Dining:** Top restaurant recommendations near WTC KL for diverse culinary experiences.
- **Ghetto Spots:** A guide to the city's vibrant nightlife with top clubs and bars near WTC KL.
- **Shopping:** Best shopping districts and local markets for a retail adventure.
- **Cultural Etiquette:** Insights into local customs and traditions for respectful interactions.
- **Useful Information:** Practical tips on currency, language, and communication.
- **Essential Apps:** Must-have apps to enhance your travel experience.
- **Departure:** Tips for a smooth departure from Kuala Lumpur.

Malaysia 101

Overview of Kuala Lumpur (KL)

Kuala Lumpur, often referred to as KL, is the vibrant capital city of Malaysia. Established in 1857, it has grown from a small tin mining town to one of Southeast Asia's most important and bustling metropolises. Today, KL is a dynamic city known for its stunning architecture, thriving business scene, and rich cultural heritage.

Cityscape

The cityscape of Kuala Lumpur is a striking blend of modern and traditional. The skyline is dominated by the iconic Petronas Twin Towers, the tallest twin towers in the world, standing at 452 meters. Nearby, the Menara KL Tower offers panoramic views of the city. KL's architecture is a mix of colonial-era buildings, modern skyscrapers, and traditional Malay houses, reflecting its diverse history.

Economic and Cultural Hub

Kuala Lumpur is Malaysia's primary economic and cultural hub. It is home to major financial institutions, multinational corporations, and a growing tech industry. The city is also a cultural melting pot, where various ethnic groups and traditions converge, making it a unique and vibrant place to explore.

Geographical Overview

Malaysia is divided into two main regions: Peninsular Malaysia, which lies on the Malay Peninsula, and East Malaysia, located on the island of Borneo. Key cities include Kuala Lumpur, the capital, and other major cities such as Penang, Johor Bahru, and Kota Kinabalu. Notable landmarks include the Petronas Twin Towers in Kuala Lumpur and Mount Kinabalu in Sabah.

Climate

Malaysia has a tropical climate characterized by high humidity and temperatures ranging from 25°C to 32°C (77°F to 89°F) year-round. The country experiences two monsoon seasons: the Southwest Monsoon (May to September) and the Northeast Monsoon (November to March).

Transportation

Kuala Lumpur boasts an extensive and efficient public transportation network. The Light Rail Transit (LRT), Mass Rapid Transit (MRT), and monorail systems connect various parts of the city, making commuting easy and convenient. Buses and taxis are also readily available. Major highways like the North-South Expressway and the Federal Highway ensure accessibility to and from the city.

Ethnic Diversity

Malaysia is a multicultural country with three main ethnic groups: Malays, Chinese, and Indians, along with indigenous peoples. Each group has its own cultural practices, languages, and traditions, contributing to Malaysia's rich cultural tapestry.

Festivals and Celebrations

Malaysia celebrates a variety of festivals reflecting its cultural diversity:

During the week of 31 July - 1 August, you can experience a variety of vibrant festivals and celebrations that reflect Malaysia's rich cultural diversity. Here are some key events happening during this period:

Hari Raya Haji (Eid al-Adha)

- **Date:** 31 July 2024
- **Description:** Also known as the Festival of Sacrifice, Hari Raya Haji is celebrated by Muslims worldwide. It commemorates the willingness of Prophet Ibrahim to sacrifice his son as an act of obedience to God. In

Malaysia, this day is marked by prayers at mosques, the sacrifice of livestock, and communal meals.

- **Celebrations:** Families gather to perform prayers, share meals, and distribute meat from the sacrifices to the less fortunate. It's a time for reflection, charity, and community bonding.

Other Ongoing Events

While Hari Raya Haji is the primary festival during this period, you can also enjoy various cultural events and activities that highlight Malaysia's diverse heritage.

- **Cultural Performances:** Look out for traditional music and dance performances in public spaces, showcasing the rich cultural tapestry of Malaysia.
- **Food Festivals:** Food stalls and markets often set up special events during festival periods, offering a chance to sample traditional Malaysian dishes.
- **Local Markets and Bazaars:** Visit local markets and bazaars to experience the vibrant atmosphere, with vendors selling everything from handicrafts to traditional clothing and festive foods.

Languages

The official language of Malaysia is Bahasa Malaysia (Malay). English is widely spoken, especially in business and tourism sectors. Other commonly spoken languages include Mandarin, Cantonese, Tamil, and various indigenous languages.

Getting to Kuala Lumpur

Major Airports and Airlines

- Kuala Lumpur International Airport (KLIA)  KLIA (KUL)

[Kuala Lumpur International Airport \(KLIA\)](#) is the main gateway to Malaysia and one of Southeast Asia's major aviation hubs. Located about 45 kilometers south of Kuala Lumpur, KLIA is known for its modern architecture, extensive facilities, and efficient services. The airport is divided into two main terminals: KLIA Main Terminal and KLIA2, which caters to low-cost carriers such as AirAsia.

- Airlines

KLIA is serviced by major international airlines such as Malaysia Airlines, Singapore Airlines, Emirates, Qatar Airways, and Cathay Pacific. Regional airlines, including AirAsia, Malindo Air, and Firefly, provide extensive connectivity within Asia. There are direct flights to and from key cities around the world, making it convenient for international visitors to reach Kuala Lumpur.

Travel Time from KL to KLIA

- **By Car or Taxi:** The travel time from Kuala Lumpur city center to KLIA is approximately 45 minutes to 1 hour, depending on traffic conditions. It is advisable to allow extra time during peak hours.
- **By KLIA Ekspres:** The KLIA Ekspres train provides a direct and fast connection from KL Sentral to KLIA, taking around 28 minutes. Trains run every 15-20 minutes from 5:00 AM to midnight.
- **By Bus:** Several bus services operate between KLIA and various points in Kuala Lumpur. Travel time by bus is approximately 1 to 1.5 hours, depending on traffic and the specific route.

Visa and Entry Requirements

- Visa Requirements

Before traveling to Malaysia, it is important to check the [visa requirements](#) based on your nationality. Malaysia offers various types of visas, including tourist visas, business visas, and conference visas. Citizens of many countries, such as the United States, the United Kingdom, Australia, and most European countries, can enter Malaysia visa-free for stays of up to 90 days.

- Applying for a Visa

For those who need a visa, the application process can typically be completed [online](#) through the eVisa system or by visiting the nearest Malaysian embassy or consulate. Required documents usually include a valid passport, completed visa application form, proof of accommodation, and a return flight ticket.

Before You Travel

Documents: Ensure you have your passport (valid for at least six months), visa (if needed), and copies of important documents.

Entry Procedures

Upon arrival, ensure you have all necessary documents ready, such as your passport, visa (if applicable), and any required health documentation. Follow the signs to immigration, where officers will check your documents and grant entry. After clearing immigration, proceed to baggage claim and then to customs.

Upon Arrival

Navigating KLIA: Follow the signs to immigration, baggage claim, and customs. Information counters and airport staff are available to assist if needed.

Currency Exchange: There are multiple currency exchange counters and ATMs throughout KLIA. It's a good idea to have some Malaysian Ringgit (MYR) on hand for immediate expenses.

Transportation: Options to get to Kuala Lumpur include the [Express Rail Link \(ERL\)](#) which connects KLIA to the city center in about 28 minutes, airport taxis, and ride-sharing services like Grab.

Staying Connected

Mobile SIM Cards: You can purchase a local SIM card at KLIA from providers such as Maxis, Digi, and Celcom. They offer various data plans to keep you connected during your stay.

Internet Access: Free Wi-Fi is available at KLIA and in many public places in Kuala Lumpur. Additionally, consider renting a portable Wi-Fi device if you need constant internet access.



MYBW Conference Details

Welcome to Malaysia Blockchain Week (MYBW) conference held in [WTC KL](#) (formerly PWTC)!

Venue Overview 📍 World Trade Centre Kuala Lumpur

- **Location:** World Trade Centre Kuala Lumpur (WTC KL), Jalan Tun Ismail, 50480 Kuala Lumpur, Malaysia
- **Proximity to Key Areas:** Centrally located with easy access to major hotels, shopping districts, and tourist attractions.

Facilities and Amenities

- **Dining Options:** On-site cafes and restaurants offering a variety of cuisines. Nearby dining options include both casual and fine dining.
- **Parking:** Ample parking spaces available for attendees with easy access to the venue. Parking fees apply.

Transportation and Access

- **Public Transport:** Convenient access via [public transportation](#) including LRT (PWTC Station) and buses.
- **Ride-Hailing Services:** Easily accessible by ride-hailing services like Grab.
- **Taxi Services:** Available at the venue's taxi stand.

About Malaysia Blockchain Week (MYBW)

[Malaysia Blockchain Week \(MYBW\)](#) is a premier event that brings together blockchain enthusiasts, industry leaders, and innovators from around the world. The conference aims to explore the latest trends, challenges, and opportunities in blockchain technology, fostering collaboration and knowledge sharing among participants.

Event Highlights

- **Keynote Speakers:** Hear from prominent figures in the blockchain industry as they share their insights and expertise.
- **Panel Discussions:** Engage in thought-provoking discussions on the latest trends, challenges, and innovations in blockchain technology.
- **Workshops:** Participate in hands-on workshops to enhance your skills and knowledge in blockchain applications and development.
- **Networking Opportunities:** Connect with industry leaders, innovators, and peers during dedicated networking sessions and social events.
- **VIP Lounge:** Exclusive area for VIP attendees to relax, network, and enjoy refreshments.
- **Networking Lounge:** A dedicated space for all attendees to meet and network.
- **Trading Lounge:** An area for discussions and negotiations, perfect for making business deals.
- **Other Lounges:** Various themed lounges offering comfortable spaces for different activities and networking opportunities.

Social Media and Online Presence

Stay connected and up-to-date with all the latest news and updates from Malaysia Blockchain Week (MYBW) through our social media channels and official website. Follow us to join the conversation, share your experiences, and network with other attendees.

- **Website:** <https://myblockchainweek.com/>
- **Twitter:** <https://x.com/MalaysiaWeek>
- **Telegram:** <https://t.me/MYBW2024>
- **LinkedIn:** <https://www.linkedin.com/company/malaysia-blockchain-week/>

We hope this information helps you navigate and enjoy Malaysia Blockchain Week (MYBW) and your time in Kuala Lumpur. Have a great conference and an enjoyable stay in this dynamic city!

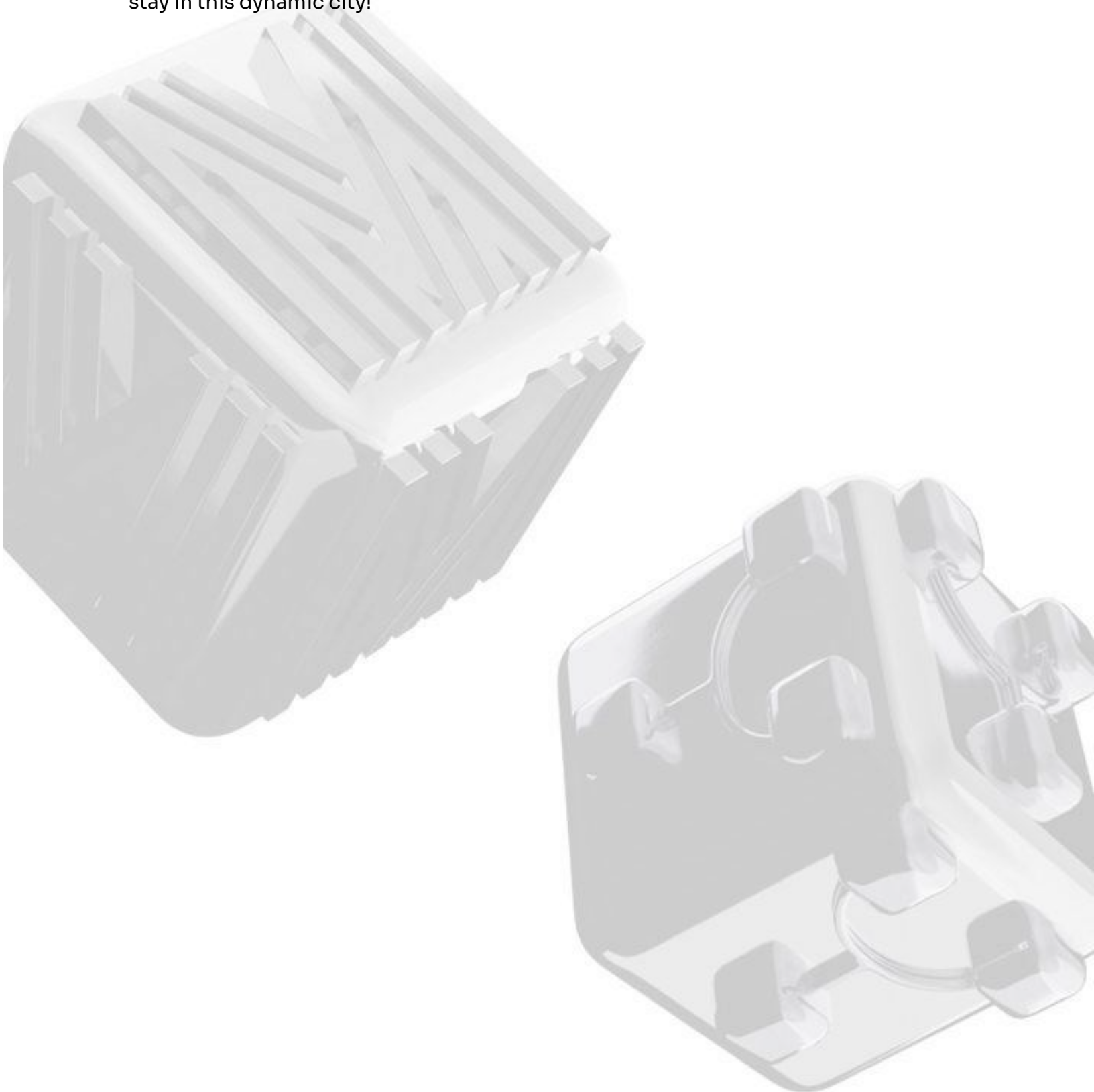

Accommodation Options in Kuala Lumpur

Luxury Hotel

1. The Ritz-Carlton Kuala Lumpur **The Ritz-Carlton, Kuala Lumpur**

- **Book Here:** [The Ritz-Carlton Kuala Lumpur](#)
- **Location:** 168, Jalan Imbi, Kuala Lumpur, 55100 Kuala Lumpur, Wilayah Persekutuan Kuala Lumpur
- **Distance to WTC KL:** Approximately 3.5 km
- **Description:** A luxury retreat in the heart of the city, The Ritz-Carlton Kuala Lumpur offers a refined ambiance with world-class amenities and exceptional service.
- **Features:** Spa, fitness center, fine dining restaurants, outdoor pool, and meeting facilities.

2. JW Marriott Kuala Lumpur **JW Marriott Hotel Kuala Lumpur**

- **Book Here:** [JW Marriott Kuala Lumpur](#)
- **Location:** 183, Jalan Bukit Bintang, Kuala Lumpur, 55100 Kuala Lumpur, Wilayah Persekutuan Kuala Lumpur
- **Distance to WTC KL:** Approximately 3.0 km
- **Description:** Situated in the vibrant Bukit Bintang area, JW Marriott Kuala Lumpur offers an opulent stay with top-notch services and elegant accommodations.
- **Features:** Full-service spa, outdoor pool, fitness center, multiple dining options, and business facilities.

3. The Majestic Hotel Kuala Lumpur

The Majestic Hotel Kuala Lumpur, Autograph Collection

- **Book Here:** [The Majestic Hotel Kuala Lumpur](#)

- **Location:** 5, Jalan Sultan Hishamuddin, Tasik Perdana, 50000 Kuala Lumpur, Wilayah Persekutuan Kuala Lumpur
- **Distance to WTC KL:** Approximately 4.5 km
- **Description:** A member of The Leading Hotels of the World, The Majestic Hotel Kuala Lumpur exudes colonial charm and offers luxurious accommodations and exceptional services.
- **Features:** Spa, outdoor swimming pool, fitness center, fine dining restaurants, and elegant event spaces.

4. Hotel Stripes Kuala Lumpur **Hotel Stripes Kuala Lumpur, Autograph Collection**

- **Book Here:** [Hotel Stripes Kuala Lumpur](#)
- **Location:** 25, Jalan Kamunting, Chow Kit, 50300 Kuala Lumpur, Wilayah Persekutuan Kuala Lumpur
- **Distance to WTC KL:** Approximately 2.0 km
- **Description:** Hotel Stripes Kuala Lumpur blends modern design with local heritage, providing a unique urban experience in the heart of the city.
- **Features:** Rooftop pool, fitness center, chic restaurant and bar, and versatile event spaces.

5. AC Hotel Kuala Lumpur **AC Hotel Kuala Lumpur**

- **Book Here:** [AC Hotel Kuala Lumpur](#)
- **Location:** 9, Jalan Lumut, Chow Kit, 50400 Kuala Lumpur, Wilayah Persekutuan Kuala Lumpur
- **Distance to WTC KL:** Approximately 1.5 km
- **Description:** AC Hotel Kuala Lumpur offers contemporary accommodations with European-inspired design, perfect for both business and leisure travelers.
- **Features:** Fitness center, outdoor pool, stylish dining options, and flexible meeting spaces.

6. Seri Pacific Hotel Kuala Lumpur Seri Pacific Hotel Kuala Lumpur

- **Location:** Jalan Putra, Chow Kit, 50350 Kuala Lumpur, Malaysia
- **Distance to WTC KL:** Approximately 0.1 km (adjacent to PWTC)
- **Description:** Located adjacent to the Putra World Trade Centre, Seri Pacific Hotel offers elegant rooms with modern amenities. The hotel features a spa, swimming pool, and several restaurants.
- **Features:** Direct access to PWTC, luxurious rooms, spa services, fine dining.

7. Hilton Kuala Lumpur Hilton Kuala Lumpur

- **Location:** 3 Jalan Stesen Sentral, Kuala Lumpur Sentral, 50470 Kuala Lumpur, Malaysia
- **Distance to WTC KL:** Approximately 6.5 km
- **Description:** Although slightly further from PWTC, Hilton Kuala Lumpur is a top choice for luxury accommodations. It offers stylish rooms, an outdoor pool, and multiple dining options.
- **Features:** Modern design, extensive facilities, proximity to KL Sentral for easy access to public transportation.

8. Sheraton Imperial Kuala Lumpur Hotel Sheraton Imperial Kuala Lumpur Hotel

- **Location:** Jalan Sultan Ismail, Chow Kit, 50250 Kuala Lumpur, Malaysia
- **Distance to WTC KL:** Approximately 2.5 km
- **Description:** This 5-star hotel offers luxurious rooms and suites, a spa, an outdoor pool, and multiple dining options. It is known for its impeccable service and elegant design.
- **Features:** Spacious rooms, exceptional service, variety of dining options, central location.

9. Grand Hyatt Kuala Lumpur Grand Hyatt Kuala Lumpur

- **Location:** 12 Jalan Pinang, Kuala Lumpur City Centre, 50450 Kuala Lumpur, Malaysia
- **Distance to WTC KL:** Approximately 5.0 km
- **Description:** Located in the heart of the city, this hotel offers stunning views of the Petronas Twin Towers and luxurious amenities, including a spa, outdoor pool, and several restaurants.
- **Features:** Prime location, luxury rooms, excellent dining options, panoramic city views.

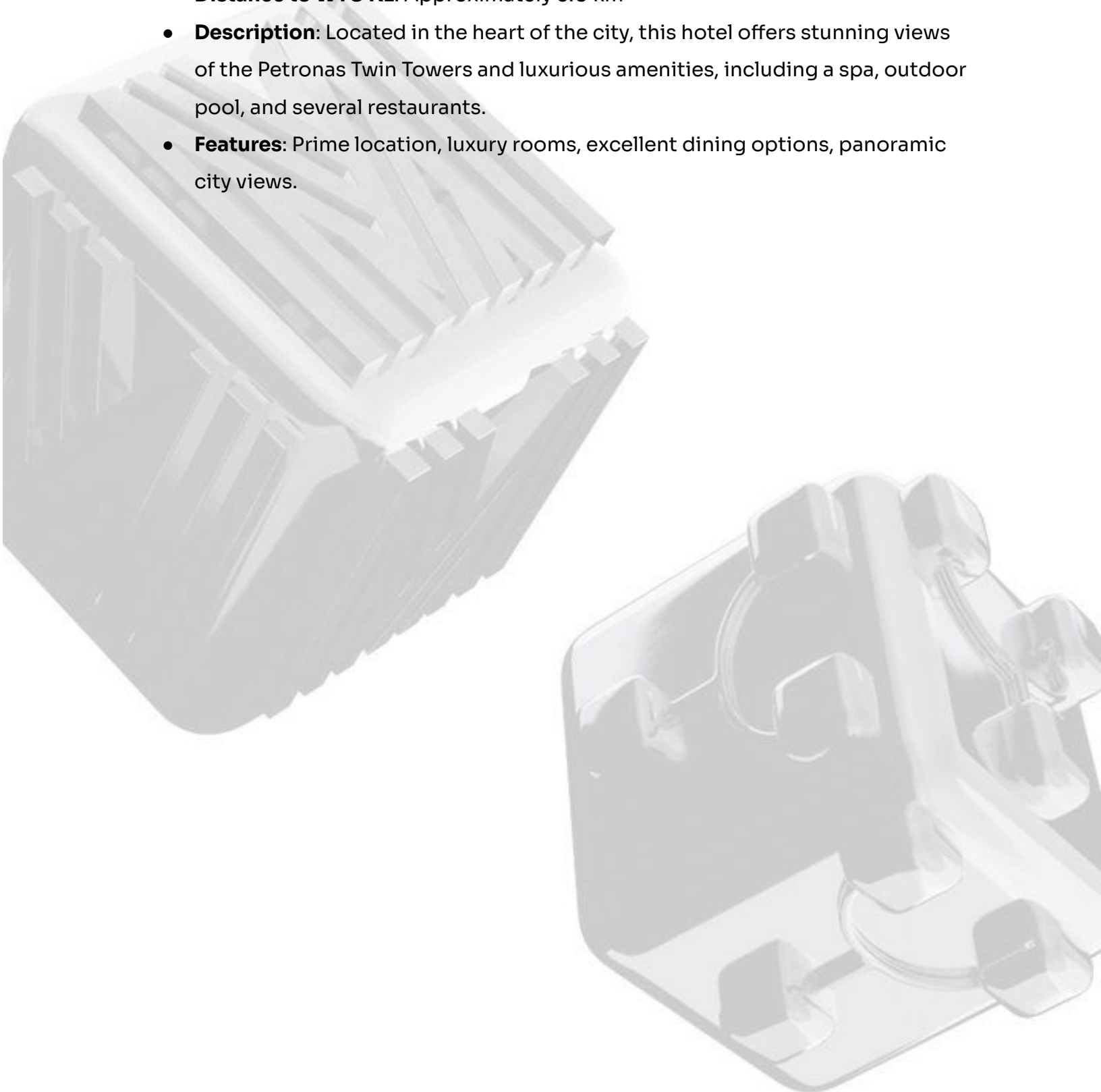

Comfort Hotels

1. Leo Palace Hotel Leo Palace Hotel @ PWTC

- **Location:** 18 Jalan Rahmat, Chow Kit, 50350 Kuala Lumpur, Malaysia
- **Distance to WTC KL:** Approximately 0.4 km
- **Description:** A budget-friendly hotel offering basic accommodations with essential amenities. It's a short walk from WTC KL.
- **Features:** Affordable rooms, free Wi-Fi, basic facilities, close to public transport.

2. Sunway Putra Hotel Sunway Putra Hotel

- **Location:** 100 Jalan Putra, Chow Kit, 50350 Kuala Lumpur, Malaysia
- **Distance to WTC KL:** Approximately 0.2 km (directly connected via a pedestrian bridge)
- **Description:** While part of a luxury brand, this hotel offers budget rooms that are affordable and well-equipped.
- **Features:** Basic rooms, free Wi-Fi, access to hotel amenities.

Others recommended hotels:

1. Intercontinental InterContinental Kuala Lumpur, an IHG Hotel

Official website: <https://kualalumpur.intercontinental.com/>

- **Location:** 165, Jln Ampang, Kuala Lumpur, 50450 Kuala Lumpur, Wilayah Persekutuan Kuala Lumpur.
- **Distance to WTC KL:** Approximately 5.0 km
- **Description:** Just steps away from the iconic Petronas Twin Towers and Kuala Lumpur Convention Centre and within walking distance to countless other shopping and entertainment activities such as spa, fitness center, swimming pool and lounge activities.
- **Features:** Prime location, luxury rooms, excellent dining option and spa.

2. Shangri-La Kuala Lumpur Shangri-La Kuala Lumpur

Official website: <https://www.shangri-la.com/kualalumpur/shangrila/>

- **Location:** 11, Jln Sultan Ismail, Kuala Lumpur, 50250 Kuala Lumpur, Wilayah Persekutuan Kuala Lumpur
- **Distance to WTC KL:** Approximately 3.0 km
- **Description:** Situated in the heart of the city, explore and discover well-known attractions and activities that Kuala Lumpur has to offer. Relax by the poolside in our tropical gardens, re-connect over drinks in our sun-drenched lounge or rejuvenate at our Health Club and Spa.
- **Features:** Prime location, luxury rooms, excellent dining option and spa.

3. The Ruma The RuMa Hotel and Residences

Official website: <https://theruma.com/en/>

- **Location:** 7, Jalan Kia Peng, Kuala Lumpur, 50450 Kuala Lumpur, Wilayah Persekutuan Kuala Lumpur
- **Distance to WTC KL:** Approximately 4.0 km
- **Description:** Nestled in the very heart of Kuala Lumpur's Golden Triangle, The RuMa means home in its most literal sense. Voted as the top 100 most incredible hotels in the world by Fodor's Travel.
- **Features:** Wellness hub with pools, spa, gym, pool bar and lounge.

How to Book

When booking your accommodation, consider using reputable online travel agencies such as [Booking.com](https://www.booking.com), [Agoda](https://www.agoda.com), or directly through the hotel's website. Booking in advance and being flexible with your dates can often secure better rates.

Limited OFFER Promotion! (Booking Period: 28 Jul - 4 Aug 2024)

[The Ritz-Carlton Kuala Lumpur](#)

[JW Marriott Kuala Lumpur](#)

[The Majestic Hotel Kuala Lumpur](#)

[Hotel Stripes Kuala Lumpur](#)

[AC Hotel Kuala Lumpur](#)

***Please note that once all rooms are fully reserved, we will no longer be able to accept any further booking requests. We encourage you to make your reservations early to secure your accommodation. Thank you for your understanding.*

HOTEL
STRIPES
KUALA LUMPUR

AUTOGRAPH COLLECTION
HOTELS



THE RITZ-CARLTON
KUALA LUMPUR



AUTOGRAPH COLLECTION
HOTELS

JW MARRIOTT
KUALA LUMPUR

Transportation in Kuala Lumpur

Public Transportation

[LRT \(Light Rail Transit\)](#) and [MRT \(Mass Rapid Transit\)](#)

Kuala Lumpur's public transportation system is efficient and user-friendly, with the LRT and MRT being the most popular modes of transport. The LRT has three main lines: the Kelana Jaya Line, Ampang Line, and Sri Petaling Line, while the MRT operates the Sungai Buloh-Kajang Line.

Major Stations Near WTC KL: The closest LRT station to WTC KL is PWTC Station on the Ampang/Sri Petaling Line. The nearest MRT station is Muzium Negara on the Sungai Buloh-Kajang Line, connected to the KL Sentral transport hub.

Route Map (Scroll Image)

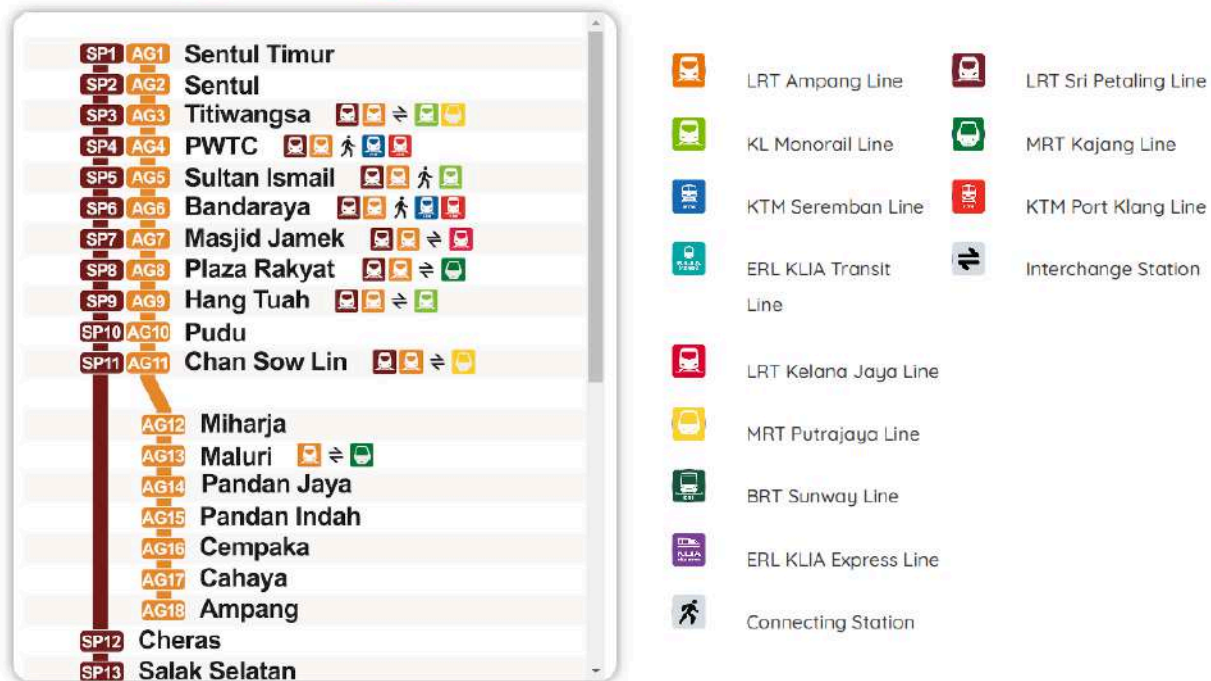

How to Use: Tickets can be purchased at kiosks or ticket counters in the stations.

Touch 'n Go cards are also available for easy, cashless travel.

Buses

Kuala Lumpur's bus network complements the rail systems, offering extensive coverage throughout the city.

Key Bus Stops Near WTC KL: Several bus routes stop near WTC KL, including services operated by [Rapid KL](#) and the [Go KL City Bus](#).

Go KL City Bus: This free service offers several routes around the city center, making it convenient for tourists. Key routes include the Green Line (KLCC to Bukit Bintang) and the Purple Line (Pasar Seni to Bukit Bintang).

Taxis and Ride-Hailing Services

Taxis: Metered taxis are available throughout Kuala Lumpur. Ensure the driver uses the meter or agree on a fare before starting your journey. Pre-booked taxi services can also be arranged through your hotel.

Ride-Hailing Apps: [Grab](#) is the most popular ride-hailing app in Malaysia, providing a safe and convenient way to get around. MyCar is another option. Always check the driver's details and car plate number before getting in.

Car Rentals and Driving Tips

Car Rental Services

If you prefer the flexibility of driving, several car rental companies operate in Kuala Lumpur.

Recommended Companies: Hertz, Avis, and local providers like [Hawk Rent A Car](#).

Rental Process: To rent a car, you will need a valid driving license and an international driving permit (if required). Most rental companies offer online booking.

Driving in Kuala Lumpur

Driving in KL can be challenging due to heavy traffic, especially during peak hours. However, it allows greater flexibility for exploring.

Road Rules: Drive on the left side of the road. Seat belts are mandatory, and using a mobile phone while driving is prohibited unless you have a hands-free system.

Parking: There are several parking facilities near WTC KL, including multi-level parking garages and open-air lots.

Navigation: Apps like Google Maps and Waze are essential for navigating KL's roads. They provide real-time traffic updates and the best routes.

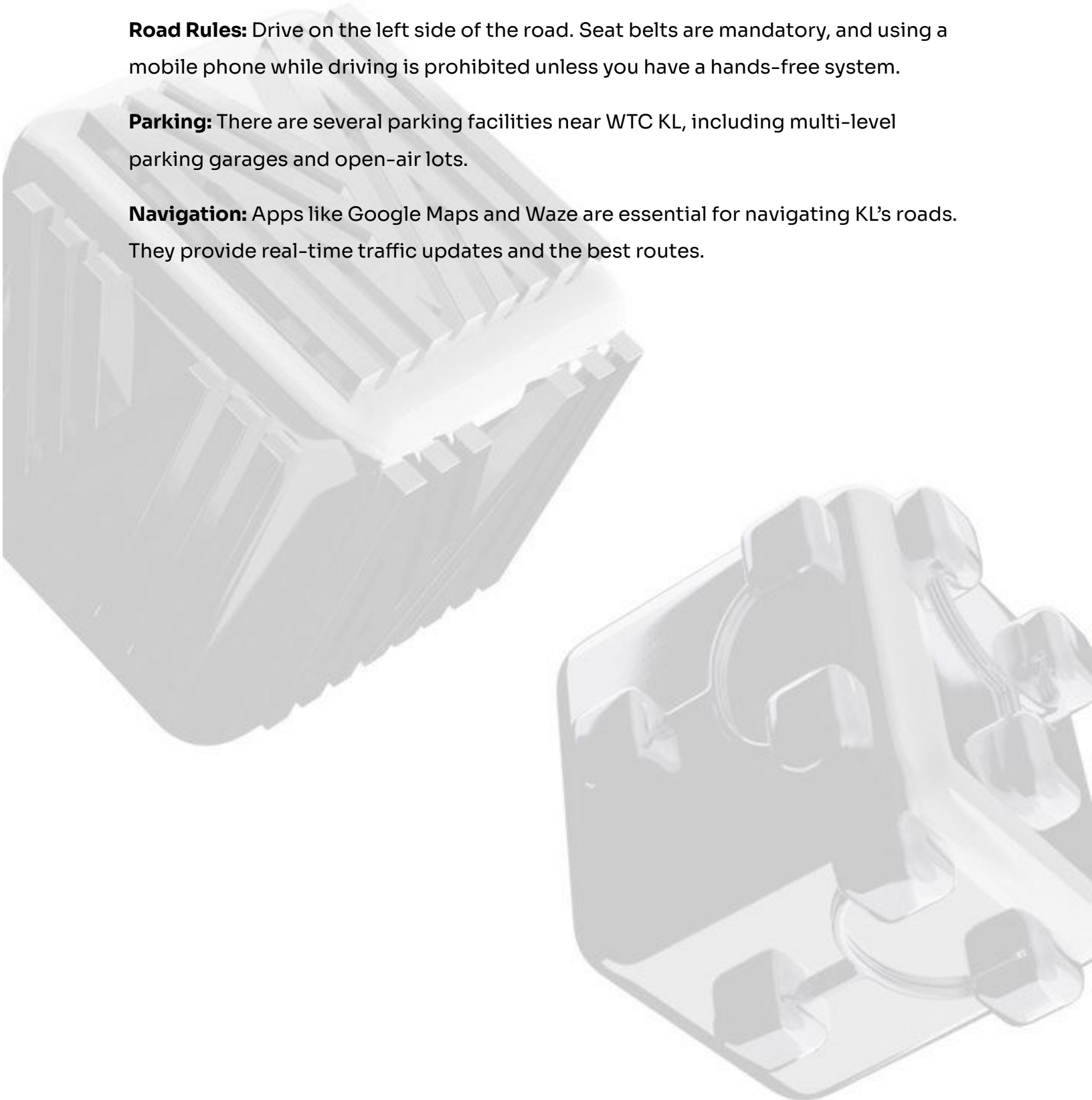

Navigating Kuala Lumpur

- **Maps and Apps**

For easy navigation, use apps like Google Maps and Waze. These provide detailed maps, real-time traffic conditions, and alternative routes. Printed maps are available at tourist information centers and hotels.

- **Travel Tips**

Avoiding Traffic: Try to travel outside of peak hours (7:00–9:00 AM and 5:00–7:00 PM) to avoid heavy traffic.

Using Public Transport: Public transportation is less crowded during non-peak hours. Plan your trips accordingly.

General Tips: Always have small change for ticket machines and tolls. Stay hydrated and wear comfortable shoes, especially if you plan to explore the city on foot.

Staying Safe in Kuala Lumpur

General Safety Tips

- Personal Safety

While Kuala Lumpur is generally safe for tourists, it's important to stay aware of your surroundings. Avoid displaying valuable items such as jewelry, cameras, and large amounts of cash. When using transportation, opt for reputable services such as registered taxis or ride-hailing apps like Grab.

- Local Laws and Customs

Malaysia has strict laws and regulations that visitors must adhere to. Respect local customs, especially in religious and cultural sites. Dress modestly, particularly when visiting mosques and temples. Avoid illegal activities, including drug use, as Malaysia has severe penalties for drug offenses.

- Health and Medical Services

Emergency Medical Services

In case of a medical emergency, dial [999](tel:999) or 112 for ambulance services. Kuala Lumpur has several hospitals and clinics that provide high-quality medical care. Some nearby hospitals include:

[Hospital Kuala Lumpur: Jalan Pahang, 50586 Kuala Lumpur.](#)

[Prince Court Medical Centre: 39 Jalan Kia Peng, 50450 Kuala Lumpur.](#)

[Gleneagles Kuala Lumpur: 286 & 288 Jalan Ampang, 50450 Kuala Lumpur.](#)

Pharmacies are widely available, with some operating 24 hours.

Health Insurance

It is highly recommended to have travel health insurance that covers medical emergencies, hospitalization, and evacuation. Ensure your insurance plan is accepted in Malaysia and keep your insurance details handy.

Emergency Contacts and Services

Emergency Numbers:

Police: 999

Fire: 999

Ambulance: 999

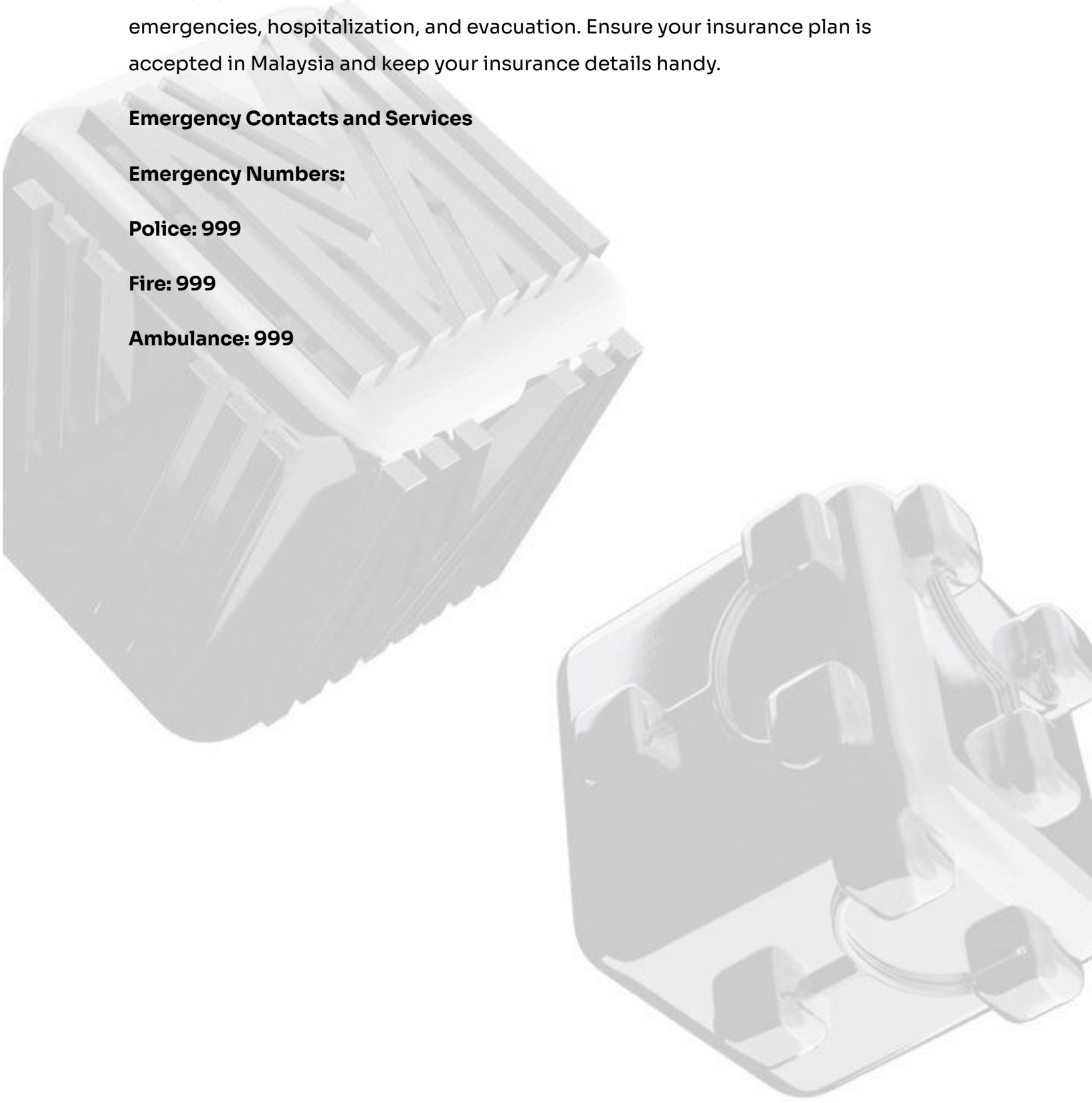

Exploring Kuala Lumpur

Top Tourist Attractions

- Petronas Twin Towers  Petronas Twin Towers

The Petronas Twin Towers, standing at 452 meters, are an iconic symbol of Kuala Lumpur. As the tallest twin towers in the world, they offer breathtaking views from the Skybridge (on the 41st and 42nd floors) and the observation deck (on the 86th floor).

Official website: <https://www.petronastwintowers.com.my>

Operating Hours: 9:00 AM - 9:00 PM (closed on Mondays).

Ticket Information: Tickets can be purchased online or at the counter. It's advisable to book in advance due to high demand.

- KL Tower  Menara Kuala Lumpur

KL Tower, or Menara Kuala Lumpur, is another prominent landmark offering panoramic views of the city. It features an observation deck, the thrilling Sky Box, and a revolving restaurant for a unique dining experience.

Official Website: <https://kltower.com.my/>

Visiting Hours: 9:00 AM - 10:00 PM daily.

Ticket Details: Tickets are available for various packages, including the observation deck and Sky Box.

- Batu Caves  Batu Caves

Batu Caves is a limestone hill with a series of caves and cave temples. It is one of the most popular Hindu shrines outside India, dedicated to Lord Murugan. The main

attraction is the large statue of Lord Murugan and the 272 steps leading to the Temple Cave.

Best Times to Visit: Early morning or late afternoon to avoid the heat and crowds.

Getting There: Easily accessible by train (KTM Komuter) from KL Sentral to Batu Caves station.

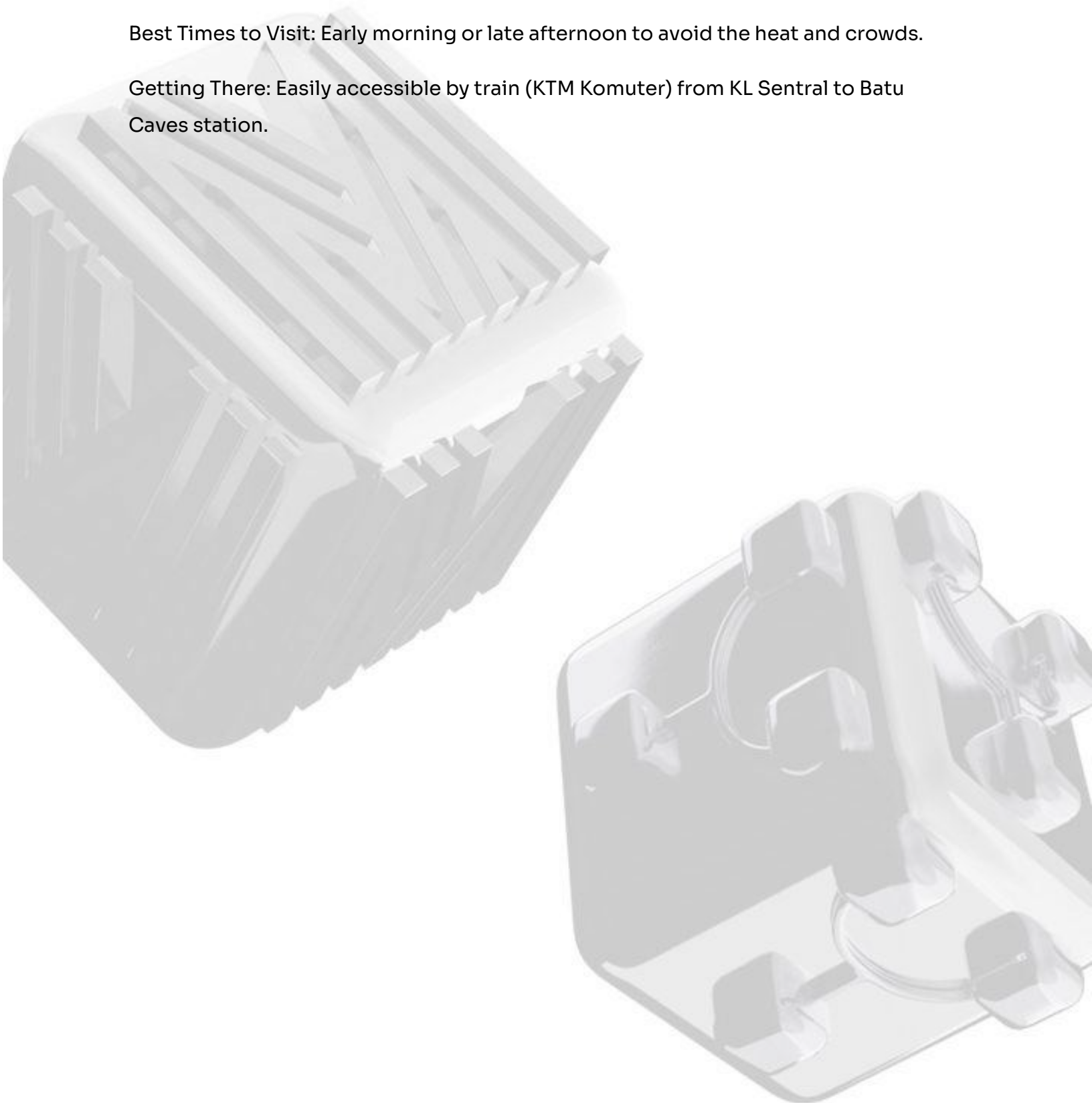

Cultural and Historical Sites

- Merdeka Square  Merdeka Square

Merdeka Square, or Dataran Merdeka, is a historic site where Malaysia declared its independence in 1957. The square is surrounded by colonial-era buildings, including the Sultan Abdul Samad Building and the National Textile Museum.

Recommended Visiting Times: Early morning or late afternoon for a cooler experience.

Nearby Attractions: Explore nearby attractions such as the Kuala Lumpur City Gallery and the River of Life.

- National Museum  The National Museum of Malaysia

The National Museum (Muzium Negara) showcases Malaysia's rich history and cultural heritage through its extensive exhibits and collections. From prehistoric artifacts to modern-day exhibits, it provides a comprehensive overview of Malaysia's past.

Official website: <https://www.muziumnegara.gov.my/>

Visiting Hours: 9:00 AM - 6:00 PM daily.

Admission Fees: Modest entry fees apply, with discounts for students and seniors.

- Thean Hou Temple  Thean Hou Temple

Thean Hou Temple is a striking six-tiered Chinese temple dedicated to the Goddess of Heaven. It is known for its grand architecture, beautiful gardens, and panoramic views of the city. The temple is a focal point for Chinese cultural and religious activities.

Official website:

<https://www.hainannet.com.my/introduction-of-the-selangor-federal-territory-hainan-association-thean-hou-temple/?lang=en>

Visiting Tips: Visit during Chinese New Year for vibrant celebrations.

Best Times to Visit: Early morning or late afternoon.



Nature and Adventure Activities

- Perdana Botanical Garden  Perdana Botanical Garden

The Perdana Botanical Garden, also known as Lake Gardens, is a lush, sprawling park in the heart of Kuala Lumpur. It features a large lake, an orchid garden, a hibiscus garden, and a deer park.

Official website: <http://www.klbotanicalgarden.gov.my/>

Opening Hours: 7:00 AM - 8:00 PM daily.

Entrance Fees: Free, but some attractions within the garden may charge a small fee.

- KL Forest Eco Park  KL Forest Eco Park

KL Forest Eco Park is an urban rainforest located near the KL Tower. It offers a unique escape from the city's hustle and bustle with its canopy walk, nature trails, and diverse flora and fauna.

Accessibility: Easily accessible from the city center.

Best Visiting Times: Early morning or late afternoon for a cooler experience.

- Bukit Nanas Forest Reserve  Bukit Nanas Forest Reserve

Bukit Nanas Forest Reserve is one of the oldest permanent forest reserves in Malaysia. It offers hiking trails and opportunities to observe local wildlife.

Entry Points: Multiple entry points, including near the KL Tower.

Visiting Tips: Wear comfortable shoes and bring water for a pleasant hiking experience.

Food and Dining

Malaysian Cuisine and Must-Try Dishes

Introduction to Malaysian Cuisine

Malaysian cuisine is a melting pot of flavors influenced by Malay, Chinese, Indian, and other ethnic culinary traditions. Food is an integral part of Malaysian culture, and sharing meals is a common way to build community and celebrate togetherness.

Must-Try Dishes



Nasi Lemak: Considered the national dish, nasi lemak is a fragrant rice dish cooked in coconut milk, served with a spicy sambal, anchovies, peanuts, boiled egg, and cucumber.



Satay: Skewered and grilled meat served with a delicious peanut sauce, often accompanied by ketupat (compressed rice cakes), cucumber, and onions.



Laksa: A spicy noodle soup with variations such as Asam Laksa (sour and fish-based) and Curry Laksa (coconut milk and curry-based).



Roti Canai: A flaky, crispy flatbread typically served with dhal (lentil curry) or other curries.



Char Kway Teow: Stir-fried flat noodles with prawns, cockles, Chinese sausage, and bean sprouts, seasoned with soy sauce.



Hainanese Chicken Rice: Poached chicken served with aromatic rice, accompanied by chili sauce and ginger paste.



Cendol: A refreshing dessert made from coconut milk, green rice flour jelly, and palm sugar syrup, often served over shaved ice.

Recommended Restaurants and Street Food near WTC KL

Recommended Restaurants

1. Restoran Kin Kin Kin Kin Restaurant

- **Cuisine:** Malaysian, Chinese
- **Specialty:** Chilli Pan Mee
- **Address:** 40, Ground Floor, Jalan Dewan Sultan Sulaiman 1, Chow Kit, 50300 Kuala Lumpur, Malaysia
- **Distance to WTC KL:** Approximately 1.5 km

2. Havelly Restaurant Havelly Kuala Lumpur

- **Cuisine:** Indian, Pakistani
- **Specialty:** Biryani, Tandoori dishes
- **Address:** 28, Jalan Tun Razak, Chow Kit, 50400 Kuala Lumpur, Malaysia
- **Distance to WTC KL:** Approximately 1.0 km

3. Mohd Yaseen Nasi Kandar Mohd.Yaseem Nasi Kandar Restaurant

- **Cuisine:** Indian, Malaysian
- **Specialty:** Nasi Kandar
- **Address:** 351, Jalan Tuanku Abdul Rahman, Chow Kit, 50100 Kuala Lumpur, Malaysia
- **Distance to WTC KL:** Approximately 1.2 km

4. Restoran Mee Rebus Abdullah

- **Cuisine:** Malaysian
- **Specialty:** Mee Rebus
- **Address:** 384, Jalan Tuanku Abdul Rahman, Chow Kit, 50100 Kuala Lumpur, Malaysia
- **Distance to WTC KL:** Approximately 1.3 km

5. Café Capitol Capital Cafe

- **Cuisine:** Western, Malaysian
- **Specialty:** Burgers, Sandwiches, Malaysian Fusion
- **Address:** 357, Jalan Tuanku Abdul Rahman, Chow Kit, 50100 Kuala Lumpur, Malaysia
- **Distance to WTC KL:** Approximately 1.3 km

6. Shin Ong Lai Restaurant Shin Ong Lai Restaurant 新旺来饭店

- **Cuisine:** Chinese
- **Specialty:** Dim Sum
- **Address:** 90, Jalan Dewan Sultan Sulaiman, Chow Kit, 50300 Kuala Lumpur, Malaysia
- **Distance to WTC KL:** Approximately 1.4 km

7. Nando's Nando's Sunway Putra Mall

- **Cuisine:** Portuguese, African
- **Specialty:** Peri-Peri Chicken
- **Address:** LG.24, Sunway Putra Mall, 100, Jalan Putra, Chow Kit, 50350 Kuala Lumpur, Malaysia
- **Distance to WTC KL:** Approximately 0.2 km

8. Onde Onde  Onde Onde @ Sunway Putra Mall

- **Cuisine:** Malaysian, Peranakan
- **Specialty:** Nyonya Laksa, Rendang
- **Address:** Level 3, Sunway Putra Mall, 100, Jalan Putra, Chow Kit, 50350 Kuala Lumpur, Malaysia
- **Distance to WTC KL:** Approximately 0.2 km

9. Restoran RSMY  RSMY

- **Cuisine:** Indian, Pakistani
- **Specialty:** Cheese Naan, Tandoori
- **Address:** 10-12, Jalan Medan Tuanku, Chow Kit, 50300 Kuala Lumpur, Malaysia
- **Distance to WTC KL:** Approximately 2.0 km

10. Boat Noodle  Boat Noodle - Sunway Putra Mall

- **Cuisine:** Thai
- **Specialty:** Thai Boat Noodles
- **Address:** Level 4, Sunway Putra Mall, 100, Jalan Putra, Chow Kit, 50350 Kuala Lumpur, Malaysia
- **Distance to WTC KL:** Approximately 0.2 km

Food Area

Jalan Alor 亚罗街

This bustling street is a haven for food lovers, offering a variety of street food options. From grilled satay to fresh fruit juices, Jalan Alor is a must-visit.

Best Time to Visit: Evening to late night for the full street food experience.

Petaling Street Jalan Petaling

Located in the heart of Chinatown, Petaling Street is famous for its vibrant market atmosphere and delicious street food. Try the Hokkien mee and roasted duck.

Best Time to Visit: Late afternoon to evening.

Dietary Restrictions

Vegetarian and Vegan Options: Many Malaysian dishes can be easily adapted to suit vegetarian and vegan diets. So don't hesitate to ask for it.

Halal Food: Malaysia is predominantly a Muslim country, and halal food is widely available. Look for the halal certification at restaurants.

Gluten-Free Options: Although not as common, gluten-free meals can be found. Stick to rice-based dishes and avoid soy sauce, which often contains gluten.

Ghetto Spots in Kuala Lumpur

1. Gēmu Dlub

- **Description:** A trendy nightclub known for its vibrant atmosphere and eclectic music mix, popular among locals and tourists alike.
- **Distance to WTC KL:** Approximately 4.5 km
- **How to Travel:** A 10-minute drive by taxi/ride-hailing service.

2. Kyo KL

- **Description:** Known for its underground vibe and cutting-edge music, Kyo KL is a hotspot for dance music enthusiasts.
- **Distance to WTC KL:** Approximately 4.0 km
- **How to Travel:** A 10-minute drive by taxi/ride-hailing service.

3. Spark Club

- **Description:** A high-energy nightclub featuring international DJs and a state-of-the-art sound system.
- **Distance to WTC KL:** Approximately 4.5 km
- **How to Travel:** A 10-minute drive by taxi/ride-hailing service.

4. Dragonfly KL

- **Description:** A popular club known for its vibrant atmosphere, great music, and themed nights.
- **Distance to WTC KL:** Approximately 4.2 km
- **How to Travel:** A 10-minute drive by taxi/ride-hailing service.

5. Havana Bar & Grill

- **Description:** A vibrant bar and grill offering Latin music, great cocktails, and a lively atmosphere.
- **Distance to WTC KL:** Approximately 4.2 km
- **How to Travel:** A 10-minute drive by taxi/ride-hailing service.

6. Jalan Changkat Bukit Bintang

- **Description:** A street famous for its nightlife, filled with bars, pubs, and clubs.
- **Distance to WTC KL:** Approximately 4.5 km
- **How to Travel:** A 10-minute drive by taxi/ride-hailing service.

7. The Iron Fairies KL  The Iron Fairies KL

- **Description:** A unique, fairy-themed bar with creative cocktails and live music.
- **Distance to WTC KL:** Approximately 4.5 km
- **How to Travel:** A 10-minute drive by taxi/ride-hailing service.

8. Marini's on 57  Marini's on 57

- **Description:** A rooftop bar with stunning views of the Petronas Twin Towers, offering cocktails and fine dining.
- **Distance to WTC KL:** Approximately 4.2 km
- **How to Travel:** A 10-minute drive by taxi/ride-hailing service.

9. TREC Kuala Lumpur  TREC Kuala Lumpur

- **Description:** A massive entertainment hub with numerous bars, clubs, and restaurants.
- **Distance to WTC KL:** Approximately 5.5 km
- **How to Travel:** A 15-minute drive by taxi/ride-hailing service.

10. Heli Lounge Bar  Heli Lounge Bar - Menara KH

- **Description:** A helipad by day and a rooftop bar by night, offering panoramic views of the city.
- **Distance to WTC KL:** Approximately 4.0 km
- **How to Travel:** A 10-minute drive by taxi/ride-hailing service.

11. WET Deck at W Kuala Lumpur  WET Deck, W Kuala Lumpur

- **Description:** A stylish poolside bar with a great view of the Petronas Twin Towers, offering cocktails and a trendy atmosphere.
- **Distance to WTC KL:** Approximately 4.5 km
- **How to Travel:** A 10-minute drive by taxi/ride-hailing service.

12. No Black Tie  No Black Tie

- **Description:** A well-known jazz bar offering live music performances in an intimate setting.
- **Distance to WTC KL:** Approximately 4.0 km
- **How to Travel:** A 10-minute drive by taxi/ride-hailing service.

13. Pisco Bar  Pisco Bar

- **Description:** A popular bar with a relaxed atmosphere, offering great cocktails, tapas, and occasional live music.
- **Distance to WTC KL:** Approximately 4.5 km
- **How to Travel:** A 10-minute drive by taxi/ride-hailing service.

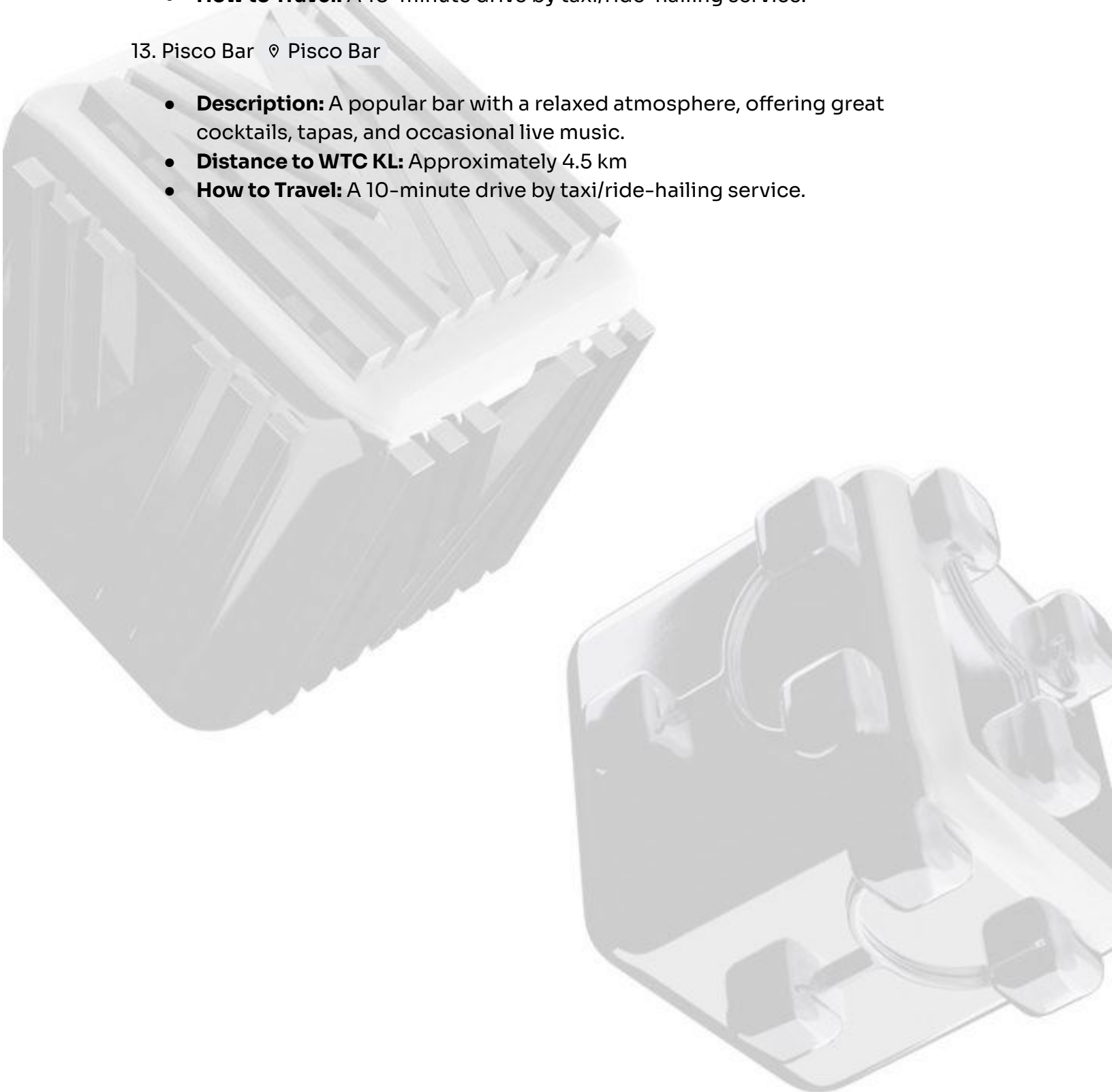



Shopping in Kuala Lumpur

Popular Shopping Districts

Bukit Bintang Bukit Bintang

Bukit Bintang is Kuala Lumpur's premier shopping and entertainment district. It's home to several major shopping malls, offering a mix of luxury brands, local boutiques, and dining options.

- Pavilion KL  Pavilion Kuala Lumpur
 - **Description:** A high-end mall featuring international brands like Gucci, Prada, and Louis Vuitton. It also has a variety of dining options and a cinema.
 - **Distance to WTC KL:** Approximately 4.5 km
- Lot 10  Lot 10
 - **Description:** Known for its trendy fashion stores and the Hutong Food Court, offering a variety of local and international cuisines.
 - **Distance to WTC KL:** Approximately 4.3 km
- Fahrenheit 88  Fahrenheit88
 - **Description:** A popular spot for mid-range shopping, with brands like Uniqlo and Sephora.
 - **Distance to WTC KL:** Approximately 4.5 km

Tun Razak Exchange (TRX) The Exchange TRX

The Tun Razak Exchange (TRX) is Kuala Lumpur's new international financial district, which also offers a premium shopping experience.

- **The Exchange TRX:** An upcoming high-end lifestyle mall featuring a blend of luxury brands, fine dining, and entertainment options.

- **Features:** Modern architecture, state-of-the-art facilities, and a vibrant retail environment.
- **Distance to WTC KL:** Approximately 5.0 km

Suria KLCC Suria KLCC

Located at the base of the Petronas Twin Towers, Suria KLCC is a high-end shopping center with a wide range of luxury brands and specialty stores.

- **High-End Brands:** Stores like Chanel, Cartier, and Tiffany & Co. can be found here.
- **Nearby Attractions:** After shopping, visit the nearby KLCC Park for a relaxing stroll or the Petronas Art Gallery for some cultural enrichment.
- **Distance to WTC KL:** Approximately 4.2 km

Mid Valley Megamall Mid Valley Megamall

Mid Valley Megamall is one of the largest shopping complexes in Kuala Lumpur, offering a wide range of stores, from fashion to electronics.

- **Variety of Stores:** Includes international brands like H&M and Zara, as well as local retailers.
- **Entertainment Options:** Features a cinema, bowling alley, and a wide range of dining options.
- **Connectivity:** Connected to The Gardens Mall, which offers more luxury shopping options.
- **Distance to WTC KL:** Approximately 8.0 km

Local Markets and Souvenirs

Central Market Central Market

Central Market, also known as Pasar Seni, is a cultural landmark in Kuala Lumpur. Originally a wet market, it has been transformed into a center for Malaysian culture, arts, and crafts.

- **Types of Goods:** Handicrafts, artwork, traditional clothing, and souvenirs.
- **Visiting Tips:** Best visited in the morning or late afternoon to avoid the crowds. Bargaining is common, so feel free to negotiate prices.
- **Distance to WTC KL:** Approximately 3.8 km

Petaling Street (Chinatown) Petaling Street Market

Petaling Street is the heart of Chinatown in Kuala Lumpur. It's known for its bustling market atmosphere and a wide range of goods.

- **Popular Items:** Clothing, accessories, electronics, and local delicacies.
- **Shopping Tips:** Be prepared to bargain and keep an eye on your belongings due to the crowded nature of the market.
- **Distance to WTC KL:** Approximately 3.5 km

Kasturi Walk Kasturi Walk

Kasturi Walk is an open-air flea market adjacent to Central Market. It offers a variety of unique items and local snacks.

- **Unique Items:** Traditional crafts, jewelry, and local snacks.
- **Best Times to Visit:** Early evening when the market is lively but not too crowded.
- **Distance to WTC KL:** Approximately 3.8 km

Shopping Safety Tips

Bargaining Tips

- **Effective Bargaining:** Start by offering a price that is about 50-60% of the asking price and negotiate from there. Always be polite and friendly.
- **Cultural Norms:** Bargaining is expected in markets and smaller shops, but not in larger retail stores or shopping malls.
- **Knowing When to Bargain:** If the price is fixed or clearly marked, bargaining may not be appropriate.

Money Exchange

- **Recommended Places:** Use official money changers in shopping malls or banks for better rates and security.
- **Avoid Street Changers:** Street money changers may offer attractive rates but are often unreliable and unsafe.
- **Best Exchange Rates:** Exchange larger amounts to get better rates and always count your money before leaving the counter.
 - Recommended P2P:
 - Telegram: @terryoh4u
 - WhatsApp: +6016-5337176

Cultural Etiquette and Customs

Do's and Don'ts

- **Do's**

Show Respect to Elders and Authority Figures: Always address elders and those in authority with respect. Use titles such as "Mr." or "Ms." followed by their last name.

Use Your Right Hand: When giving or receiving items, use your right hand or both hands. The left hand is considered unclean in many cultures.

Dress Modestly: Especially in rural areas and religious sites, ensure your attire covers shoulders and knees.

Remove Your Shoes: It's customary to remove shoes before entering homes, mosques, and some temples.

Greet with a Bow or Nod: A slight bow or nod is a common way to greet someone respectfully.

- **Don'ts**

Avoid Pointing Your Feet: Pointing your feet at people or religious objects is considered disrespectful.

Do Not Touch Someone's Head: The head is seen as the most sacred part of the body, so avoid touching it.

Avoid Public Displays of Affection: Refrain from kissing or hugging in public.

Do Not Raise Your Voice: Maintaining a calm demeanor and avoiding anger in public is important.

Use Your Right Hand: Avoid using your left hand for giving and receiving items.

Understanding Local Customs

- **Religious Practices**

Malaysia is home to several major religions. Understanding and respecting these practices is crucial.

Islam: The predominant religion. Respect prayer times and dress modestly near mosques.

Buddhism and Hinduism: Temples are sacred spaces. Often it would require removing shoes and dress modestly when visiting.

Christianity: Churches are places of worship where respectful attire is expected.

Behavior in Public

Respect local customs and traditions in public places.

Common Greetings: "Selamat pagi" (Good morning), "Selamat petang" (Good afternoon), and "Selamat malam" (Good evening).

Restaurants and Markets: Be polite to staff and vendors. Bargaining is common in markets, but do so respectfully.

Public Transportation: Offer your seat to the elderly or disabled. Keep noise levels low.

Religious Sites: Cover arms and legs. Women may need to cover their heads when visiting mosques.

Appreciation and Gratitude: Express thanks with a smile and a nod. "Terima kasih" means "thank you" in Bahasa Malaysia.

Useful Information

Currency and Banking

Malaysian Ringgit (MYR)

The official currency of Malaysia is the Malaysian Ringgit, abbreviated as MYR and often symbolized as RM. Common denominations include:

Notes: RM1, RM5, RM10, RM20, RM50, RM100.

Coins: 5 sen, 10 sen, 20 sen, 50 sen, RM1.

Banking Services

Malaysia has a well-developed banking system. Major banks include Maybank, CIMB Bank, Public Bank, and RHB Bank.

ATMs: Widely available in cities and towns. Ensure the ATM accepts your card type (Visa, MasterCard, etc.). Be cautious and use ATMs in well-lit, secure locations.

Currency Exchange: Available at banks, official money changers, and airports. Compare rates to get the best deal.

Payment Methods

Cash vs. Card: Cash is widely used, especially for small purchases and in rural areas. Credit and debit cards are accepted in most urban businesses.

Mobile Payments: E-wallets like [GrabPay](#) and [Touch 'n Go eWallet](#) are increasingly popular.

Tipping: Not customary but appreciated for good service. A 10% service charge is often included in restaurant bills.

Language and Communication

Official Language

The official language of Malaysia is **Bahasa Malaysia (Malay)**. Here are some basic phrases:

Hello: "Selamat datang"

Thank you: "Terima kasih"

Please: "Sila"

Yes/No: "Ya/Tidak"

English is widely spoken, especially in business and tourism sectors, making it easy for visitors to communicate.

Other Languages

Mandarin and Tamil are also commonly spoken, reflecting the diverse ethnic communities in Malaysia. Learning a few phrases in these languages can be helpful and appreciated by locals.

Communication Services

Mobile Phone Options: Purchase a local SIM card from providers like Maxis, Celcom, or Digi. Plans vary, so choose one that suits your data needs.

Internet Access: Free Wi-Fi is available in many hotels, cafes, and public areas.

Emergency Contacts:

Police, Fire, Ambulance: 999

Internet and Mobile Connectivity

Getting Connected

Purchasing a local SIM card is easy and affordable. Providers like Maxis, Celcom, and Digi offer a range of prepaid plans. Portable Wi-Fi devices are also available for rental at the airport and major electronic stores.

Internet Access

Free Wi-Fi is widely available in hotels, cafes, and public areas. For more consistent access, consider purchasing a local SIM card with a data plan.

Mobile Apps

Transportation: Grab for ride-hailing and public transport information.

Food Delivery: Foodpanda, GrabFood for a variety of dining options delivered to your location.

Language Translation: Google Translate for real-time translation.

Local Information: MySejahtera for health declarations and local COVID-19 updates.

Essential Apps

Transportation Apps

Grab

Grab is the leading ride-hailing app in Malaysia, offering a convenient and reliable way to get around Kuala Lumpur. You can book rides, get fare estimates, and make cashless payments through the app.

- **Availability:** Download [here](#).

MyCar

MyCar is another popular ride-hailing service that offers competitive pricing and an easy booking process. It's a good alternative to Grab.

- **Availability:** Download on [iOS](#) or [Android](#).

KLIA Ekspres

The KLIA Ekspres app is essential for travelers heading to and from Kuala Lumpur International Airport. It provides timetable information, ticket booking, and real-time updates.

- **Availability:** Download [here](#).

AirAsia MOVE

The AirAsia app is your gateway to affordable and convenient air travel across Asia and beyond. It provides a seamless experience for booking flights, managing reservations, and staying updated on flight statuses.

- **Availability:** Download on [iOS](#) or [Android](#).

MYBW2024 (RM3 Off x 2 rides)

12. Voucher is valid for both new and existing users.
13. Valid for two (2) redemptions per user.
14. airasia ride shall be available to users on a best effort basis.
15. Toll fare is not included in the fare price displayed on the mobile application after setting the destination.
16. Voucher is not valid for ongoing promotions, discounts, vouchers and/or privileges.
17. Offer purchased is not refundable/exchangeable with other promotions/offers.
18. No cancellation is allowed after the voucher has been redeemed.
19. Any surplus or remaining balance from the total amount must be paid directly by the customer or user.
20. Voucher is only applicable within the Federal Territory of Kuala Lumpur.
21. Promotion is valid from 27 July 2024 - 4 August 2024.
22. Terms and conditions of AirAsia Ride Sdn. Bhd. applies.

MYBWRIDE (RM5 Off x 2 rides Airport)

10. Voucher is valid for both new and existing users.
11. Valid for one (2) redemption per user.
12. airasia ride shall be available to users on a best effort basis.
13. Toll fare is not included in the fare price displayed on the mobile application after setting the destination.
14. Voucher is not valid for ongoing promotions, discounts, vouchers and/or privileges.
15. Offer purchased is not refundable/exchangeable with other promotions/offers.
16. No cancellation is allowed after the voucher has been redeemed.

17. Any surplus or remaining balance from the total amount must be paid directly by the customer or user.
18. Voucher is only applicable to/from KLIA1, KLIA2 and Sultan Abdul Aziz Shah Airport.



Food and Dining Apps

GrabFood

GrabFood is a food delivery service by Grab, offering a wide range of restaurant options, real-time tracking of orders, and cashless payment options.

- **Availability:** Download [here](#).

Foodpanda

Foodpanda is another popular food delivery app in Malaysia, known for its extensive selection of restaurants and promotional offers.

- **Availability:** Download [here](#).

Navigation and Maps

Google Maps

Google Maps is essential for navigating Kuala Lumpur. It offers turn-by-turn navigation, public transport routes, and real-time traffic updates.

- **Availability:** Download on [iOS](#) or [Android](#).

Waze

Waze is a community-driven navigation app that provides real-time traffic updates and route suggestions based on current traffic conditions.

- **Availability:** Download on [iOS](#) or [Android](#).

Language and Translation

Google Translate

Google Translate is useful for translating languages, with features such as text translation, voice translation, and camera translation.

- **Availability:** Download on [iOS](#) or [Android](#).

Papago

Papago is another translation app, particularly useful for Asian languages. It offers text and voice translation, as well as image translation.

- **Availability:** Download on [iOS](#) or [Android](#).

Local Information and Services

Go KL City Bus

The Go KL City Bus app provides information on the free bus service in Kuala Lumpur, including bus routes, schedules, and real-time bus locations.

- **Availability:** Download on [iOS](#) or [Android](#).

Departure from Kuala Lumpur

Preparing for Departure

Travel Documents

Before you leave, ensure you have all necessary travel documents:

Passport: Check that your passport is valid for at least six months beyond your departure date.

Visa: Verify if you need a visa for your next destination and ensure it is in order.

Flight Tickets: Have a printed or digital copy of your flight tickets.

Confirming Travel Arrangements

Flight Times: Double-check your flight times and set reminders.

Transportation: Arrange your transportation to the airport in advance. Confirm the pick-up time and location with your hotel or service provider.

Hotel Check-out: Confirm the check-out time with your hotel and request a late check-out if needed.

Airport Procedures

Getting to the Airport

Several options are available for getting to Kuala Lumpur International Airport (KLIA):

Taxi or Ride-Hailing: Book a taxi or ride-hailing service like Grab. Allow ample time for traffic.

Public Transport: The KLIA Ekspres train provides a fast and direct route to the airport from KL Sentral.

Check-in and Security

Online Check-in: Check-in online to save time. Most airlines allow online check-in 24 to 48 hours before departure.

Arrival Time: Arrive at the airport at least 3 hours before international flights.

Security Procedures: Follow all security procedures, including removing laptops and liquids from your bag. Wear easily removable shoes.

Customs and Immigration

Clearing Customs: Declare any items as required by law and follow the instructions for customs checks.

Duty-Free Shopping: Take advantage of duty-free shopping for last-minute gifts and souvenirs. Be aware of duty-free allowances for your destination country.

Final Tips and Recommendations

Feedback and Reviews

Provide Feedback: Share your experiences by providing feedback to your hotel and service providers.

Leave Reviews: Write reviews on platforms like TripAdvisor or Google to help future travelers and improve services.

Staying Connected

Contact Information: Ensure you have the contact details of new acquaintances and business contacts.

Follow-Up: Stay in touch with people you met during the conference via email or LinkedIn.